

AIRPACK: The full pressure provider.

If high air pressure is required, the AIRPACK is the answer! It is used wherever large air volumes at high pressure are required. Its impressive power means it can supply several LEISTER air heaters in parallel. The AIRPACK delivers sufficient pressure to efficiently supply Leister blow-off nozzles.

High pressure blower

AIRPACK



Technical data AIRPACK

Design: regenerative blower

Frequency	Hz	50	60
Air flow (20 °C)	l/min	3900	4500
Static pressure	kPa	30.0	30.0
Max. ambient temperature	°C	40	40
Max. air inlet temperature	°C	40	40
Noise emission level	dB(A)	73	73
Environmental protection (IEC 60529)		IP 54	IP 54
Outside diameter air inlet	Ø mm	60	60
Outside diameter air outlet	Ø mm	60	60
Weight	kg	26	26
Mark of conformity		CE	CE
Approval mark		Ⓢ	Ⓢ
Protection classe I		⊕	⊕

Installation dimensions in mm

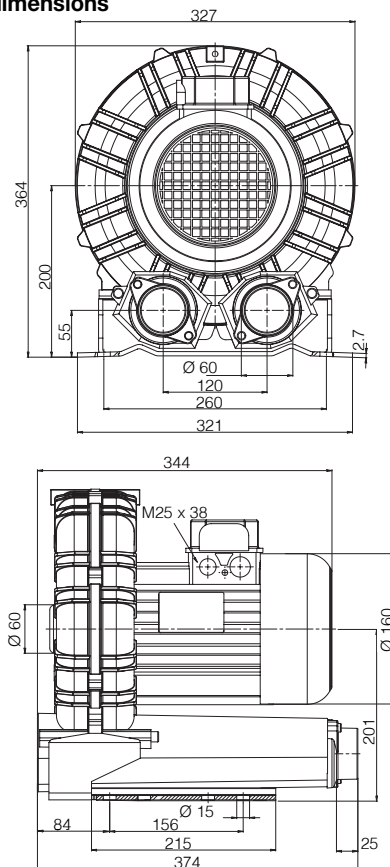

Voltage	V~ 50Hz	3 × 230 / 400
	60Hz	3 × 440 – 480
Power consumption	W	2200
Without cable	Order no.	119.358

Additional versions available on request

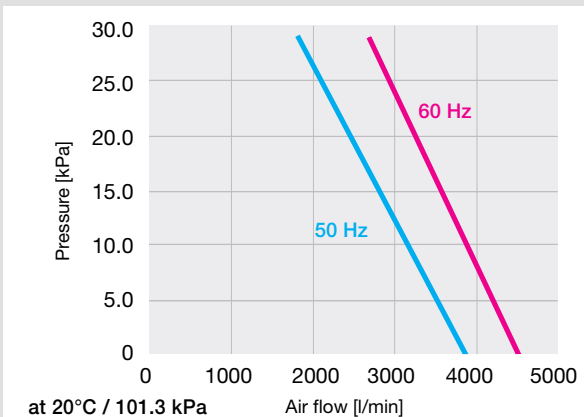







➔ Accessories page 61

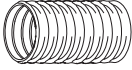
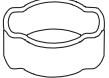

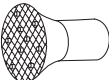
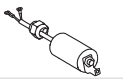
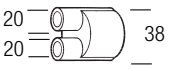

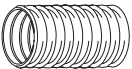
The combination of blow-off nozzles and blowers allows fast and efficient drying of beverage bottles.

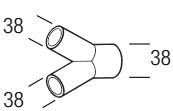
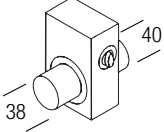
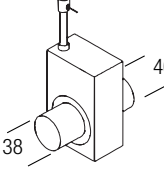

Accessories ROBUST (Ø 38 mm)

107.350		PVC air hose, Ø 19 mm
107.290		Hose clip for Ø 19 mm air hose
107.242		Closing cap Ø 19 mm attachable to hose connection adaptor 107.298
107.354		Stainless steel filter push-fit on air intaker
108.623 104.017		Motor capacitor 230 V~ Motor capacitor 120 V~
107.298		Hose connection adaptor, push-fit on ROBUST blower and adaptor 107.293 for hose connection
107.281		Hose connection adapter (Ø 38 mm), 3 outputs, each 14 mm
107.286		PVC air hose, Ø 38 mm
107.287		Hose clip for Ø 38 and Ø 60 mm air hose
107.241		Closing cap Ø 38 mm push-fit on hose connection adaptors 107.292 and 107.293
107.293		Hose connection adaptor, push-fit
108.755		Hand operated air flow adjuster and on/off switch. Size 214 x 88 x 133 mm
107.296 107.299		Air flow off/on switch The air flow is interrupted on command (pneumatic 500 kPa) to the heaters. Size 214 x 88 x 133 mm

Accessories AIRPACK (Ø 60 mm)

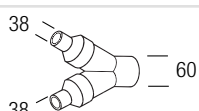
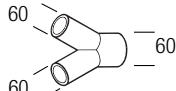
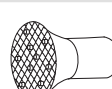
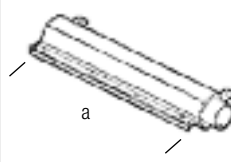
107.287		Hose clip for Ø 38 and Ø 60 mm air hose
107.241		Closing cap Ø 38 mm push-fit on hose connection adaptors 107.292 and 107.293
107.288		PVC air hose, Ø 60 mm
107.240		Closing cap Ø 60 mm, push-fit on hose connection adaptors 107.278
107.291		Hose connection adaptor with 1 air outlet for Ø 60 mm hose. Push-fit on air outlet
107.292		Hose connection adaptor with 2 air outlets for Ø 38 mm hose. Push-fit on air outlet
107.278		Hose connection adaptor, Push-fit on air outlet
110.895		Stainless steel filter push-fit on air intaker
125.907 125.908		Blow-off nozzle, push-fit Outlet opening adjustable 1 - 5.5 mm a = 300 mm a = 482.6 mm Connector Ø 60 mm

Blowers

Special nozzles on request

If using non-Leister blowers or accessories, Leister does not provide any warranty for its products.